

KIA TELLURIDE 2024 >>

Part number: ATM4004A

US  **WARNING**

Improper installation of the trailer wiring can result in serious electrical shock, vehicle damage, or fire. Always disconnect the battery before installation. Installation should be performed by a qualified professional.

 **WARNING:**

This product can expose you to chemicals including **Lead**, which is known to the State of California to cause cancer and birth defects or other reproductive harm.

For more information, go to www.P65Warnings.ca.gov

FR  **AVERTISSEMENT**

Une mauvaise installation du câblage de la remorque peut entraîner des chocs électriques, des dommages au véhicule ou un incendie.

Débranchez la batterie avant l'installation. L'installation doit être effectuée par un professionnel qualifié.

 **AVERTISSEMENT:**

Ce produit peut vous exposer à des substances chimiques, y compris le Plomb, reconnues par l'État de Californie comme Pour plus d'informations, visitez www.P65Warnings.ca.gov

ES  **ADVERTENCIA**

Una instalación incorrecta del cableado del remolque puede provocar descargas eléctricas, daños al vehículo o incendios.

Desconecte la batería antes de instalación. La instalación debe ser realizada por un profesional calificado.

 **ADVERTENCIA:**

Este producto puede exponerlo a sustancias químicas, incluido el Plomo, que el estado de California reconoce como causante de cáncer, defectos de nacimiento u otros daños reproductivos.

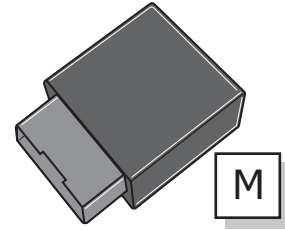
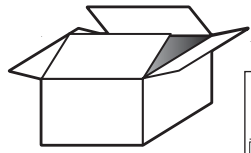

M1

R

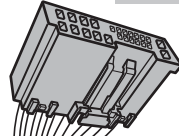
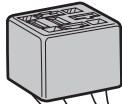

G I



* Pink: Back Up
Blue: Electric Trailer Brake
Black: Ignition power

X

R1

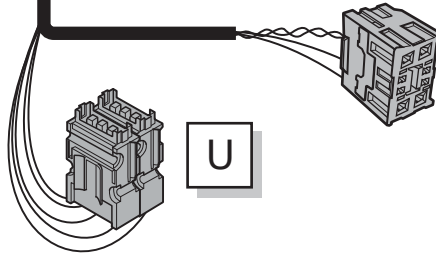
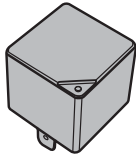

U

L

15x

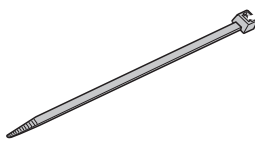

1x

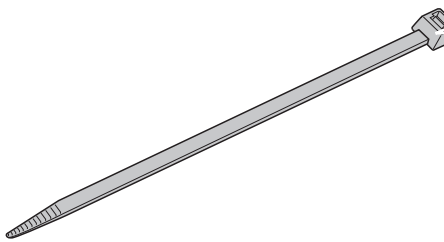

2x

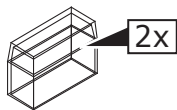

2x

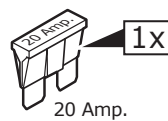

1x

20 Amp.

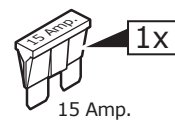

1x

15 Amp.

INFO

	BK	BN	BU	GY	GN	WH	YE	OG	PE	PI	RD
(US)	Black	Brown	Blue	Grey	Green	White	Yellow	Orange	Purple	Pink	Red
(FR)	Noir	Marron	Bleu	Gris	Vert	Blanc	Jaune	Orange	Violet	PI	Rouge
(ES)	Nero	Marrón	Azul	Gris	Verde	Blanco	Amarillo	Naranja	Morado	Rosa	Rojo

ROUTING

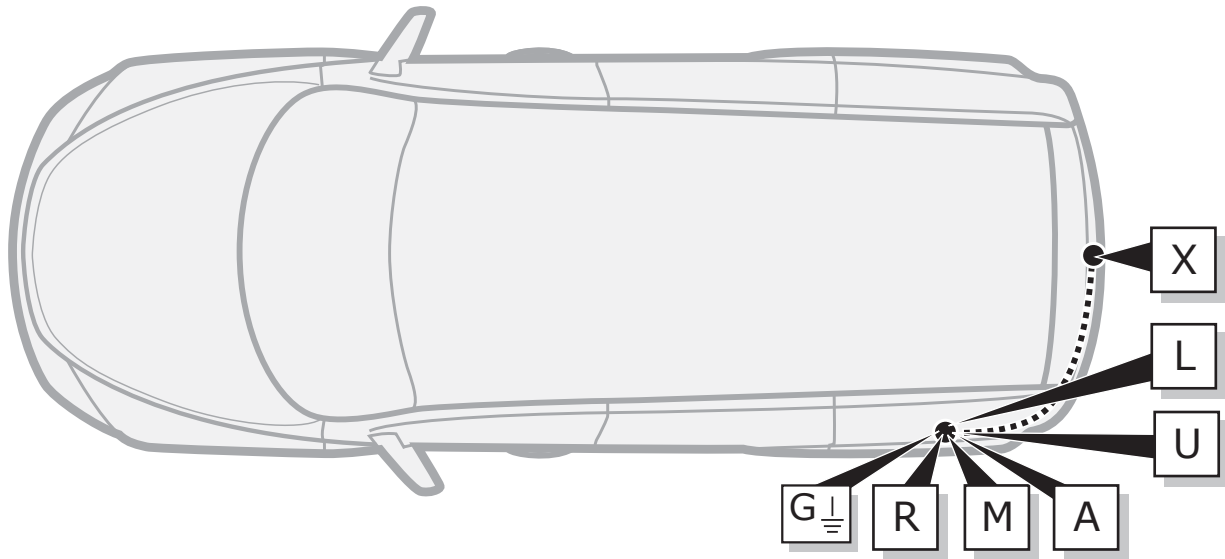

1

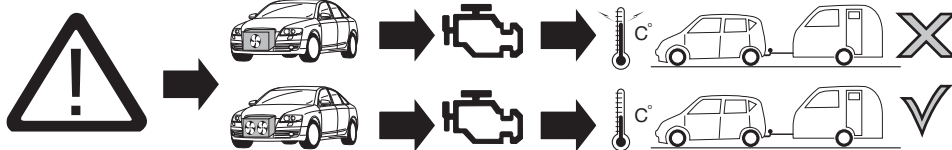

ATTENTION!

(US)

The vehicle's cooling capacity may have to be increased when retrofitting a trailer coupling! You must observe the manufacturer's instructions!!

ATTENTION!

(FR)

Il peut s'avérer nécessaire d'augmenter la puissance du radiateur du véhicule lorsque celui est équipé ultérieurement d'un attelage remorque! Respecter impérativement les instructions du constructeur!!

¡ATENCIÓN!

(ES)

¡Es posible que haya que aumentar la capacidad del radiador en caso de reequipar un acoplamiento de remorque! ¡Rogamos tener en cuenta las instrucciones de fabricante sin falta!

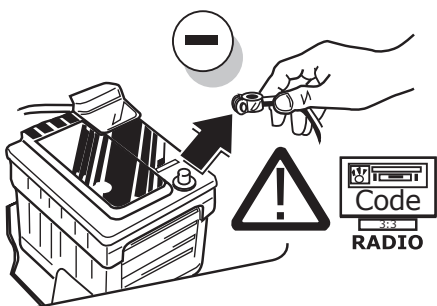

(US)

In order to avoid mal-functions and damage to the vehicle's electrical system the earth terminal must be disconnected from the vehicle's battery before starting work! Both the trailer module and the vehicle's control unit for the electrical system can be damaged during work on the CAN data bus connections if the battery is not disconnected! Please pay attention to the manufacturer's instructions when disconnecting and reconnecting the vehicle's battery!

(FR)

Afin d'éviter tout dys-fonctionnement ou endom-magement du circuit de bord, il est indispensable de débrancher la pince de masse de la batterie du véhicule avant le début de toute opération! En particulier s'il s'agit de travaux et de branchements effectués sur le bus de données CAN, si la batterie n'est pas débranchée, le module remorque aussi bien que le dispositif de commande de circuit de bord du véhicule risquent d'être endommagés! Veuillez respecter les directives du fabricant lors du branchement et du débranchement de la batterie du véhicule!

(ES)

¡Para evitar fallos y defectos en el sistema eléctrico de a bordo es imprescindible separar al terminal de puesta a tierra de la batería del vehículo antes de realizar cualquier trabajo! ¡Particularmente al realizar trabajos y conexiones al bus de datos CAN puede estropearse tanto el módulo para remolques como el regulador del sistema eléctrico de a bordo del vehículo si no se ha desconectado la batería! ¡Rogamos observar las instrucciones del fabricante al conectar y desconectar la batería del vehículo!

2

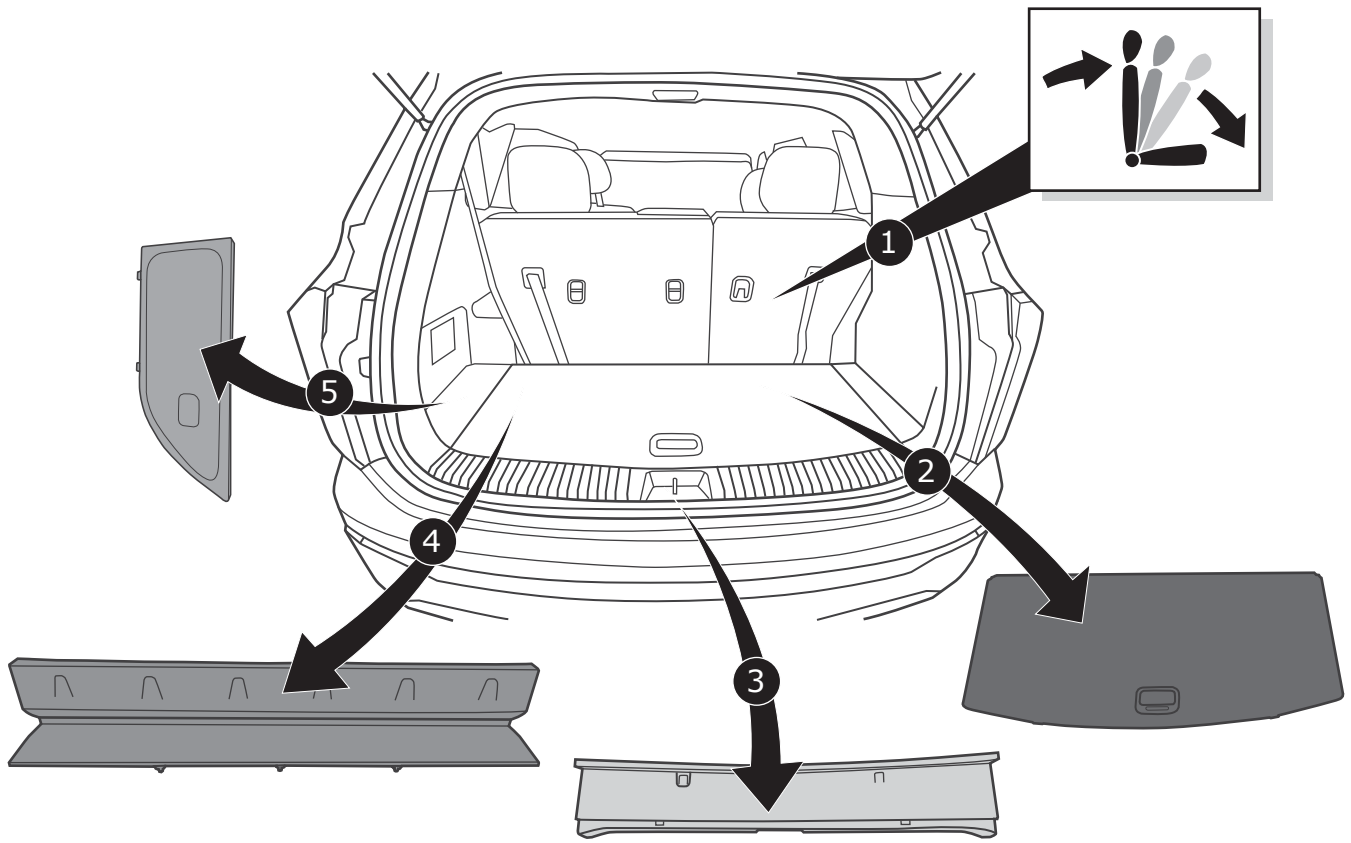

3

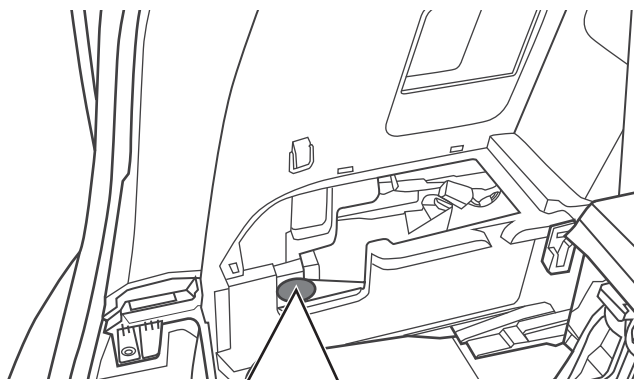
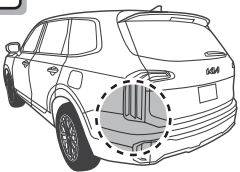

X

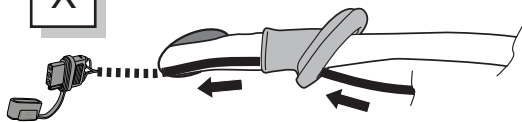

1

- (US) Remove tape.
- (FR) Enlevez Ruban adhésif.
- (ES) Retirar la cinta adhesiva.

2

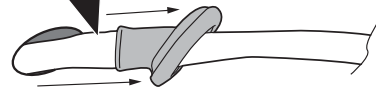

X

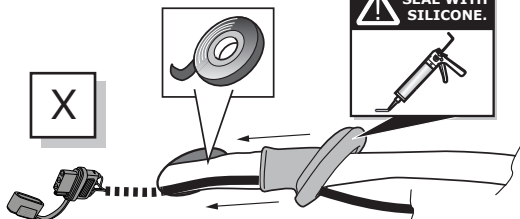

3

- (US) Socket connection
- (FR) Connection de la prise
- (ES) Conexión de la caja de enchufe

	➔	➜	☀	⏚ 1-3
	1/RT	2/LT	3/58RT	3/R
Pmax	60W	60W	90W	
	GN	YE	BN	WH

4

OPTION 7 PIN SOCKET

- (US) Remove tape.
- (FR) Enlevez Ruban adhésif.
- (ES) Retirar la cinta adhesiva.

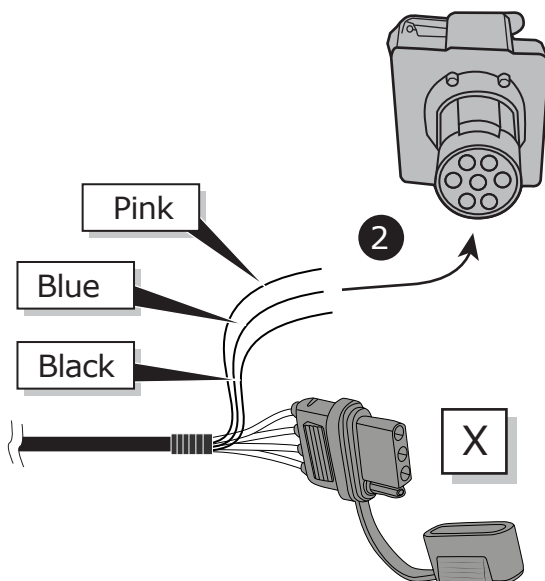
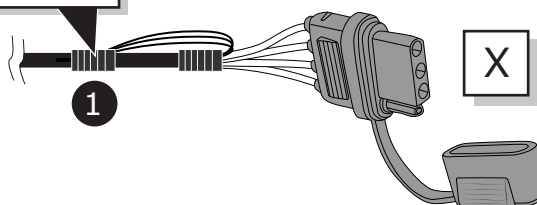

Please order at U-Haul
with partnr: 47185

- * Pink: Back Up
- Blue: Electric Trailer Brake
- Black: Ignition power

5

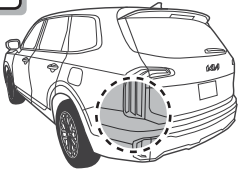

- (US) Remove tape.
- (FR) Enlevez Ruban adhésif.
- (ES) Retirar la cinta adhesiva.

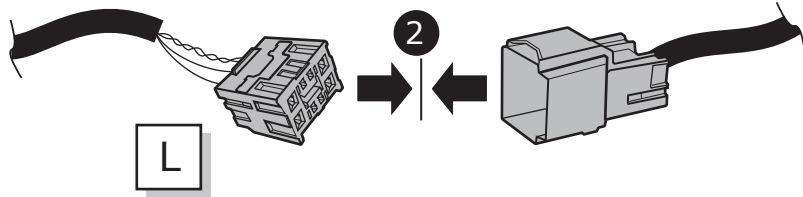
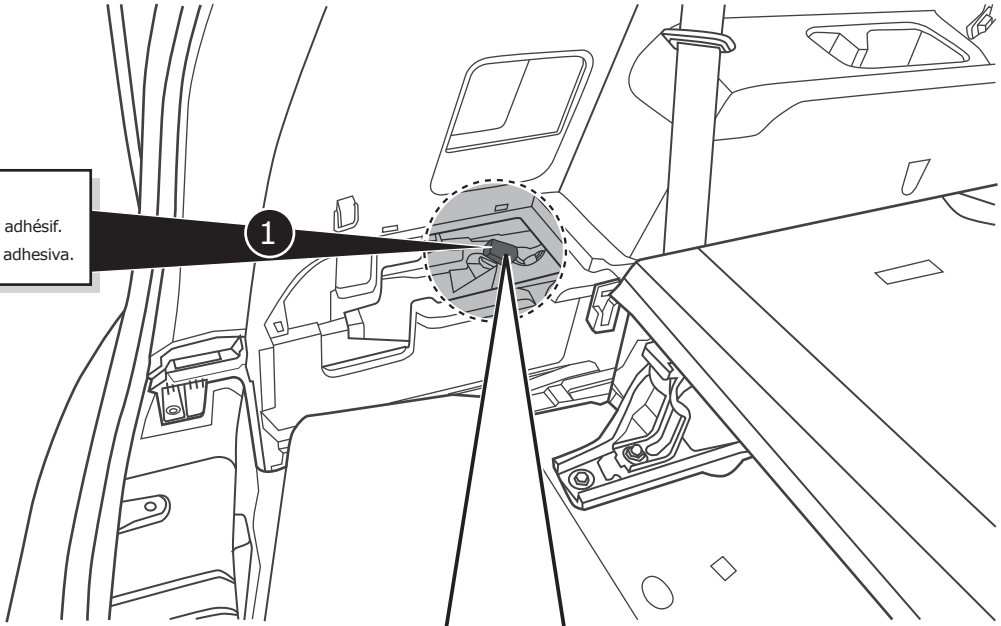

6

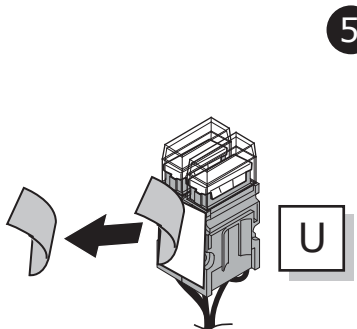
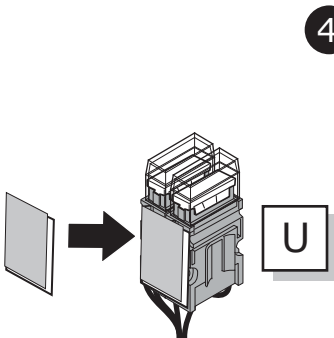
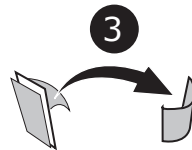
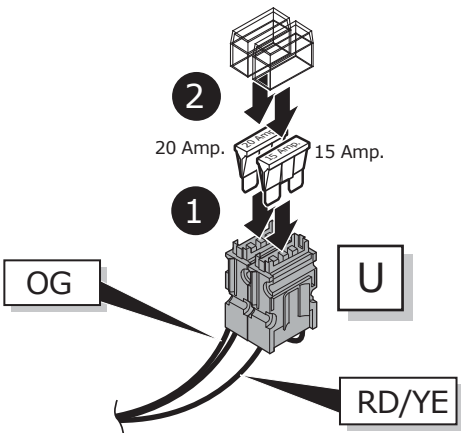

7 Only when 7 pin is required

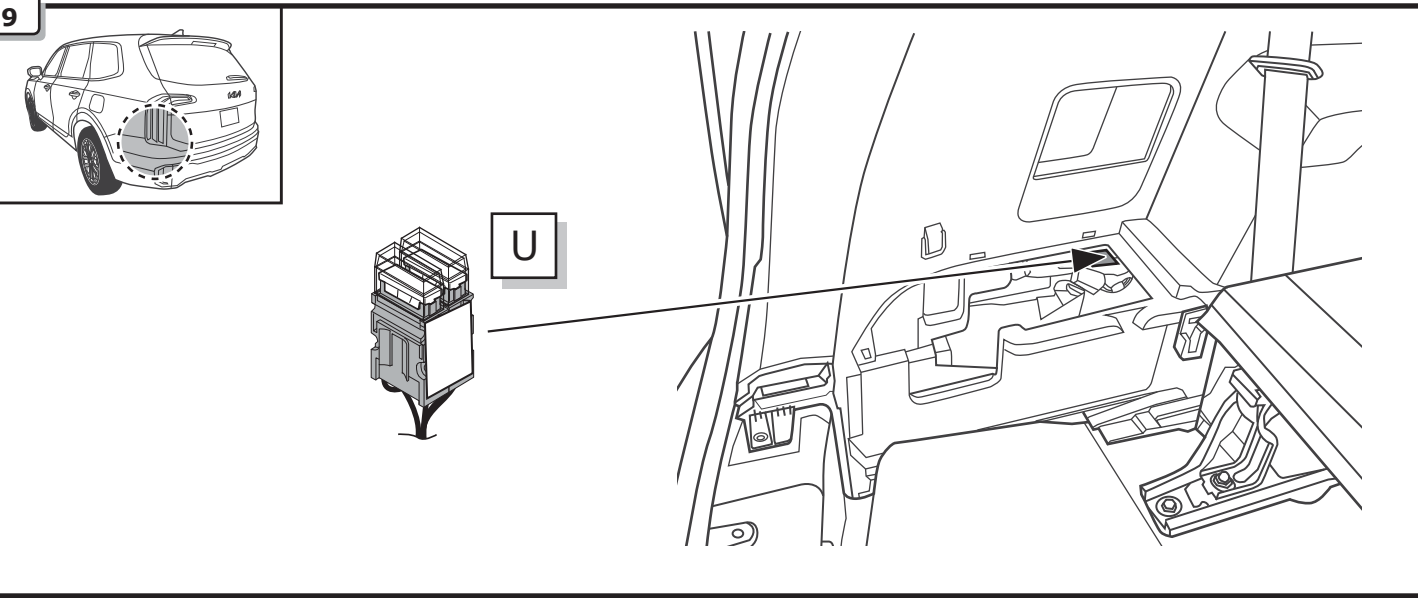
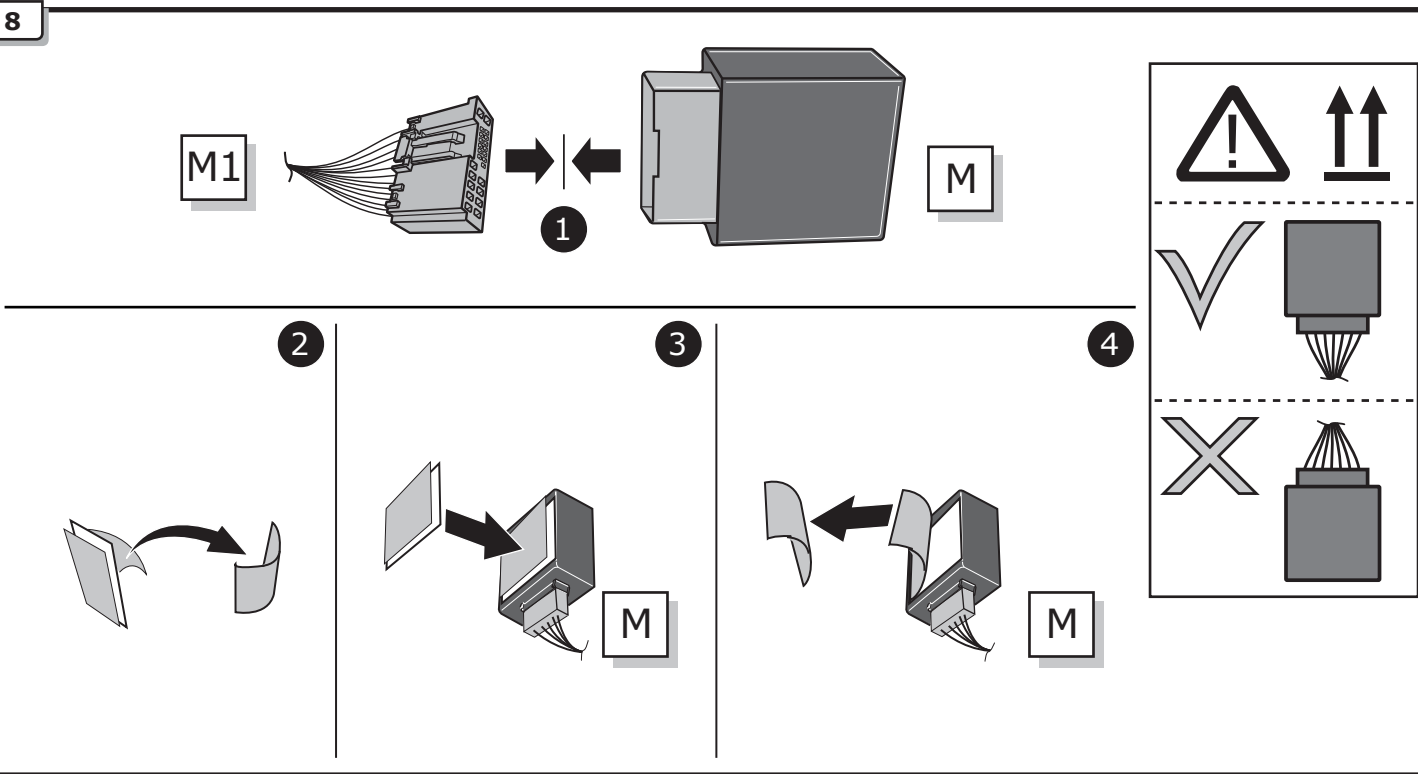
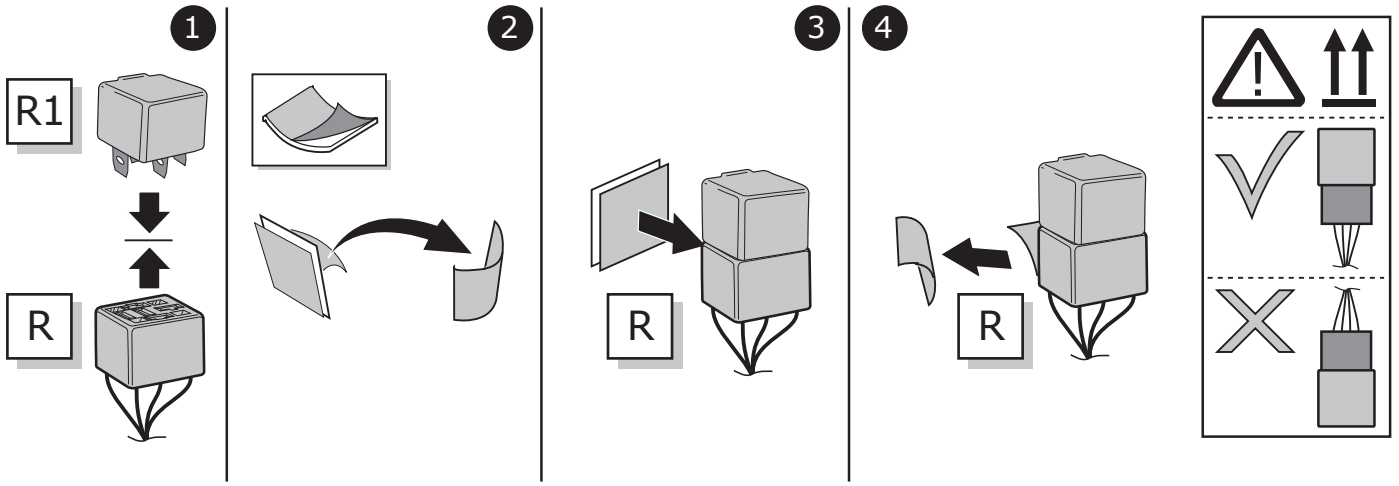

10

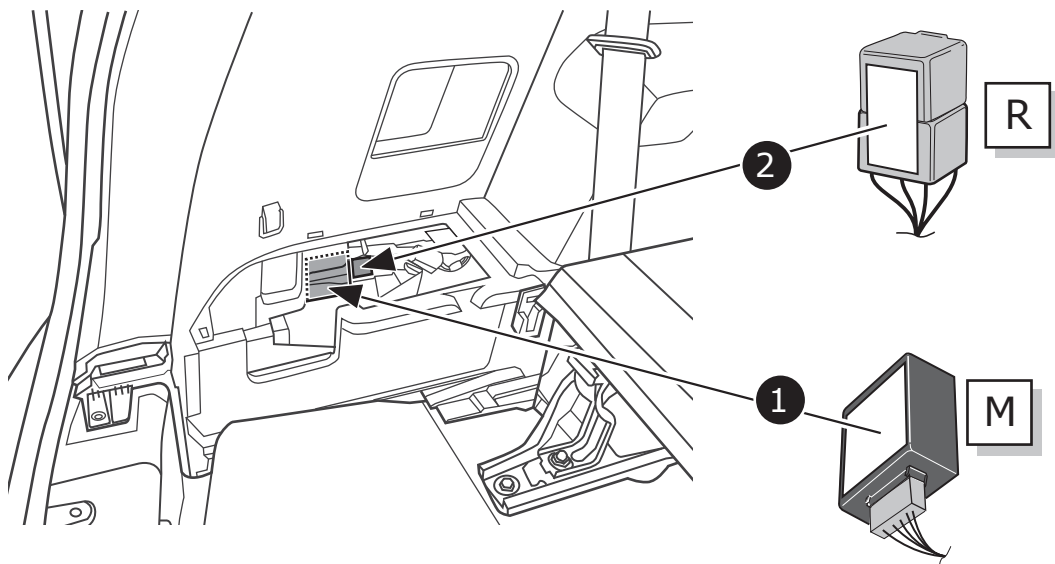
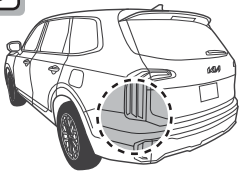

11

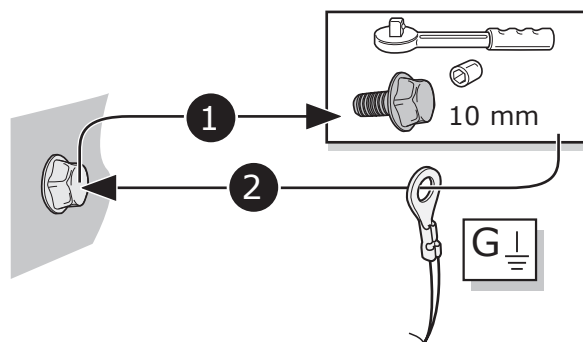
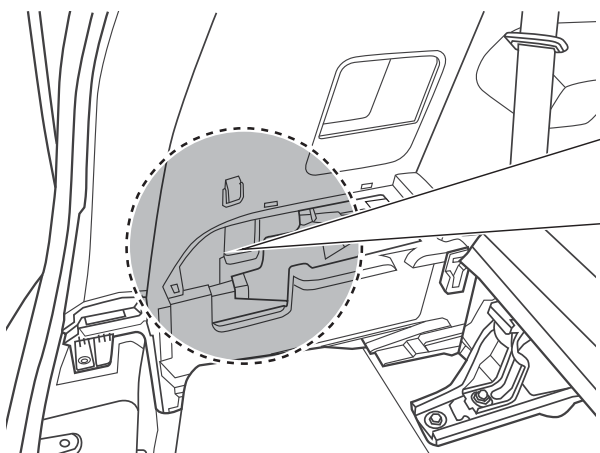
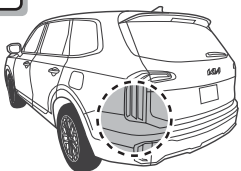

12

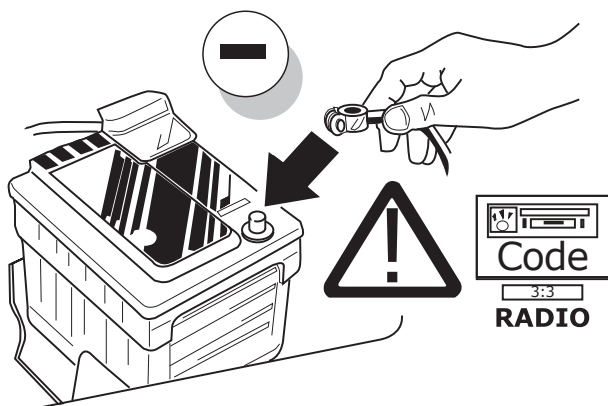

Functional test

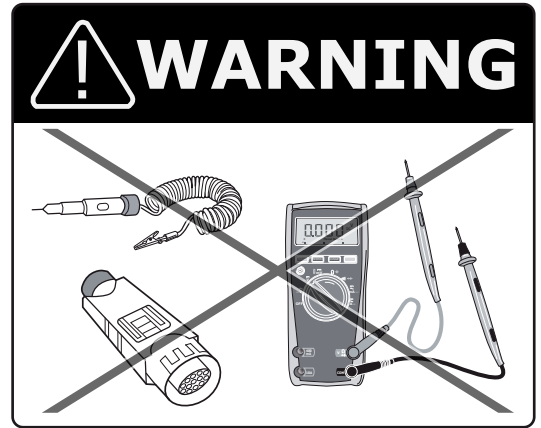
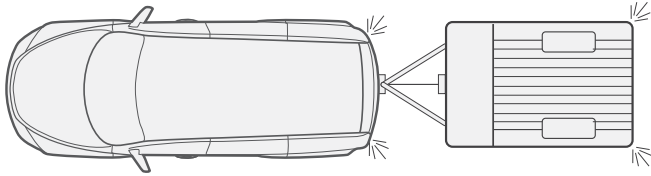
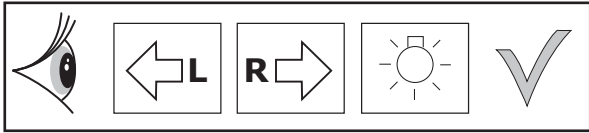

- (US) Ensure trailer's lamps draw 1W of power or greater (In case of LED lamps with low power consumption)
- (FR) Assurez-vous que les lampes de la remorque consomment au moins 1 W de puissance (dans le cas des lampes LED à faible consommation).
- (ES) Asegúrese de que las luces del remolque consuman 1 W de potencia o más (en caso de luces LED con bajo consumo de energía).

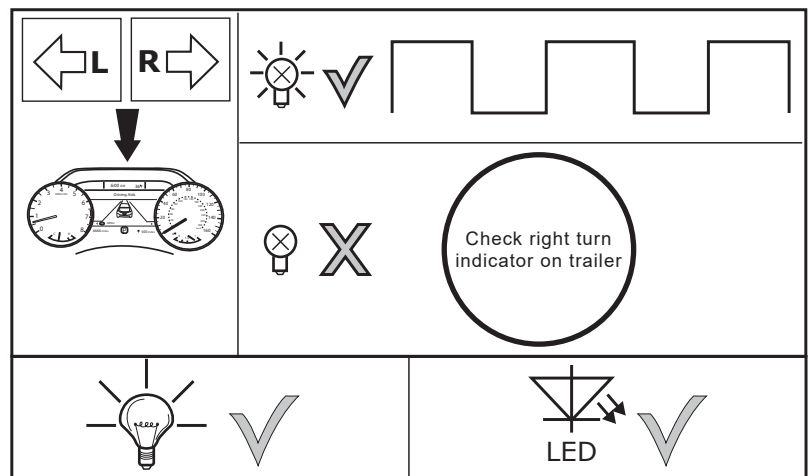
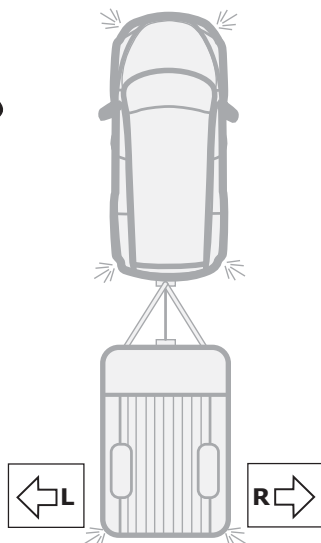

15

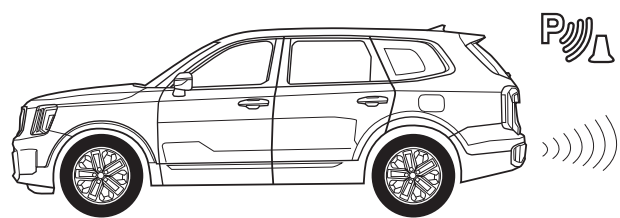
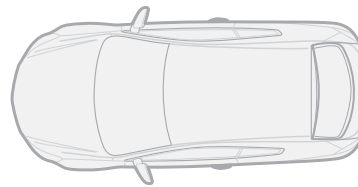
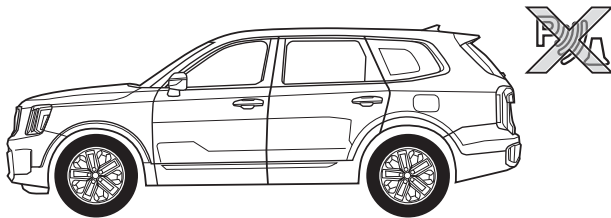
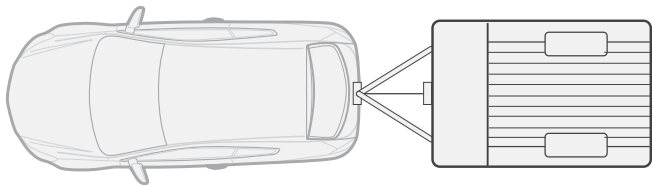

16

